

Ffestiniog Railway Fairlie power bogie.

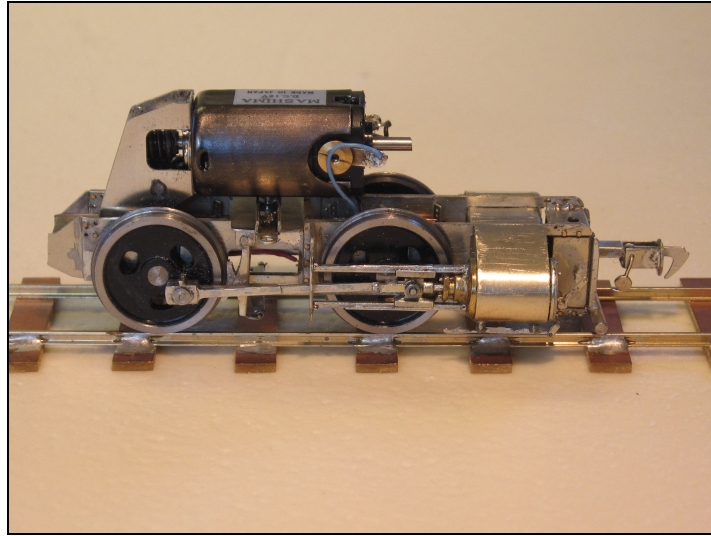

A 7mm scale kit for 14mm and 16.5mm gauges.

Designed by Clee Model Engineers
Marketed by **EDM**
19 Briar Avenue
Acomb
York YO26 5BX

Design, development, and manufacture.	3
Skill Level.	3
These instructions.	3
Prototype History and Images	3
Scale and Gauge	4
Other Variations.	4
General Assembly Instructions.	5
Tips	5
Pins and Rivets	6
Assembly method.	6
1. Main frames.	7
2. Front buffer beam.	10
3. Crosshead, cylinder end casting and connecting rods.	12
Cylinder block.	13
4. Motor & Gearbox.	15
5. Wheel sets and coupling rods.	17
6. Main Assembly	19
7. Pick ups.	23
Running Checks	23
8. Detailing	24
7.1 Crash bar	24
7.2 Brake assembly	24
7.3 Drain cocks	25
7.4 Lubricator	26
Wiring and DCC options.	28

Design, development, and manufacture.

This kit is collaboration of myself, Peter Balderston (C.M.E.) and Paul Martin of EDM. I have developed the design of etched and cast parts. EDM has supplied the ‘mechanical parts’, motor, gears, wheels, etc.

This is the second commercial 7mm kit that I have designed. The first, Linda and Blanche, taught me a lot about how to go about things. There are some things that are wrong, some have changed, and some could be better. Help me improve things, I need your input. Please comment via the 7mm NGA website, or contact EDM directly. I can not change things just for one persons view, but collectively you can help the continuous development of this kit, and of the other I intend to produce. Thank you.

Skill Level.

This kit is intended for modellers with good soldering and metalworking skills. It is unsuitable for assembly using glue. Because of so many variations in the prototypes you need to carefully assess what parts you need, and what may need to be modified.

These instructions.

I suggest you print off this written set of instructions, and then load up the preferred set of images and pictures onto a computer, and use these as a reference as required.

Part numbers are referred to in parenthesis, ie (101)

Assembly pictures are referred to as Fig xxx

Prototype images are referred to as Img xxx

The figures occurring in the instructions are also located in a separate directory if you would like to enlarge them.

Prototype History and Images

There are currently seven Fairlie bogies in use on the Ffestiniog railway, identified as A - G. In addition, two bogies exist under ‘Livingston Thompson’, usually exhibited at the National Railway Museum in York, and two ‘new’ bogies being constructed at Boston Lodge, intended to replace those under David Lloyd George. How much of the existing bogies will be use is not known at present.

(From the Fairlie appeal....)

“To summarise the present position, there are currently nine bogies in existence, with two further under construction. The present locations are:

Bogies A and B – built 1988 (original 1880s rods and wheel centres) – Earl of Merioneth

Bogies C and D – built 1886 – David Lloyd George

Bogie E – completed 1998 – Taliesin

Bogies F and G – completed 2005 – Merddin Emrys

Original 1879 Merddin Emrys frames with James Spooner wheels and rods, under Livingston Thompson in York Museum

New C and D bogies to go under David Lloyd George are under construction using funds from the FR Society Fairlie Appeal.”

You are urged to seek out the history of these bogies in two classic summaries of their history, titled ‘Musical bogies’ by Jo Clulow and others on the FR Society website.

If you intend to model the pre 1946 period the bogies differed in a number of ways. The rear stretcher was a plain square end, and did not include the steam brake. The front bufferbeam also had a curved return at the bottom, guard irons, and of course an FR dumb buffer and chain link coupling.

Scale and Gauge

This kit designed for use with 1/43rd (7mm = 1 foot) models. It can be built for 14mm gauge, using the narrow or wide cylinder block and motion brackets, or for 16.5mm gauge using the wide cylinder block and motion brackets.

The wide cylinder block version is representative of C and D bogies as of late 2010, but may not be in later years, as some sort of standardisation is proposed. This may mean a sacrifice to reality if you run on 16.5mm gauge track.

Other Variations.

The main design changes made since the 1920's affect the ends of the bogies. At the rear the location of the steam brake has meant an addition to the side frames. The front buffer beam has also changed to accommodate the chopper couplings now used.

I can not include pictures of the 1920's versions for copyright reasons. If you need to see these details you will need to search out period photographs.

Other detail variations between bogies are the mounting bracket for the brake block hanger, the shape of the brake blocks, and the type of drain cock and actuating mechanism.

General Assembly Instructions.

My preference is to solder as much together as is possible, and I like working in nickel silver sheet and brass.
This is not a kit that can be glued together.

Take care with sharp edges and points. Wear eye protection if using wirecutters. Do not use your best cutter to cut piano wire, it is very hard.

Full blow by blow instructions are not given. This kit is for experienced modellers, who have good soldering and metalworking skills. Personally I have always used Savbit solder, Fry's flux, and two Weller irons, a 45W TCP and a W60. Recently a resistance soldering unit and solder paste have also given good results. These may seem large, but the mass of nickel silver and brass builds up, and the rule of 'clean and hot' applies to all soldered joints. All parts are cleaned with a fibre stick (from 7mm Association sales) before applying a little flux.

Note that some kits have some parts in the boiler and saddle tank assemblies that require a long reach, small diameter soldering iron, or iron tip.

For rounded parts I use a piece of plywood with a wood lip on two sides a square to solder against. A couple of small hardwood pushers are also used to form the pieces against the square lip.

Bending formers are 22 and 15mm copper water pipe, and assorted pieces of brass and steel. A set of small rolls, such as the 'GW' rolls is highly recommended, but not essential.

I clean up all joints using scalpels, sometimes to 'carve' soft solder to shape, a brass bristle brush (sold in shoe shops for cleaning suede), and the fibre stick again. When all is complete a wash with 'Shiny Sinks' before painting. Note that nickel silver is a much better for paint to key to than brass.

All other tools are the best I can afford, Valorbe files, Lindstrom wire cutters, good stainless tweezers and scalpels with new sharp blades are essential. 2mm and 1/8" parallel reamers are useful but not essential to fit gearbox and axle parts.

I advise great caution using high speed mini drills and grinding wheels. Nickel Silver can build up on the wheels causing high surface temperatures. They can be unwantainly destructive and possibly dangerous. Hand tools offer more control.

Clean out any slots with the point of a scalpel. Note that we do not ask the etch company to 'etch clean', that is make sure all holes are etched right through. This is because in doing so most of the half etch rivet detail gets lost. We believe modellers can clean out holes more easily than restore the rivet detail !

Drill out small diameter holes (0.55mm etc) whilst the parts are still contained by the tags in the fret.

Always take great care removing parts from the fret. You can use a fine tooth (80 TPI) fretsaw, but this can sometimes lead to difficulties supporting the fret as you work. I find the best way to extract pieces is to ensure you know which tags to cut, turn the fret upside down, and run a heavy knife (Swan Morton Scalpel No 4 or 'Stanley' knife with new, sharp blade, is ideal), pulling towards you, but holding the fret away from you, over the tags a number of times on a flat surface. They will then crack, and the piece extracted undamaged. This technique is especially useful for long thin parts, such as the valance strip.

Tips

No 1 : When soldering moving parts together with a pin, use a paper washer between the parts to prevent the solder 'wicking' and fixing everything together. Use thin paper (cigarette paper or detail paper). Tear the 'washer' away after soldering.

No 2. When attaching nuts to sheet material use plenty of flux on the inside, then thread a bolt through, and tighten up on the nut. Apply plenty of solder, and release the bolt as soon as the solder has solidified. Use brass

nuts when little use is expected, eg attaching domes and chimneys, and steel nuts when used more, eg attaching chassis.

Pins and Rivets

I use a home made rivet punch, powered by a 4oz hammer. I have made the anvil (lower) part of the press with a cut out to allow very slim right angle pieces to be rivetted after folding, once this is done there is not a problem rivetting the angle brackets, (see Fig W1 & W2) for bunker or cab corners.

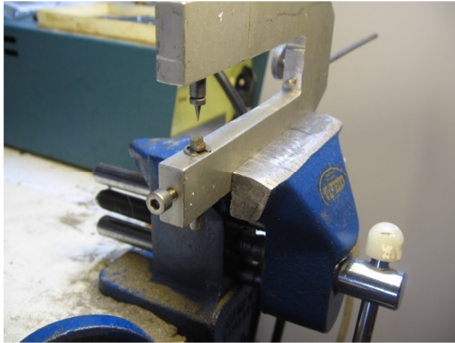

Fig. W1



Fig. W2

Thin brass pins are used locate and fix many parts together. As a general rule do not fit too many pins together at one time, hold in place by pressing onto a piece of cork floor tile or soft wood, solder together ensuring the solder flows to the pin by capillary using heat and flux. Remove and trim with a good pair of flush wire cutters.

The best pins are brass 0.55mm, use a number 74 or 0.55mm drill to open out holes, buy at least 5 at a time ! Use the point end to align parts, keep all 'off cuts', and the head end is useful in the valve gear assembly. I usually get at least 6 'joints' out of each pin, plus a head and tip.

The pins supplied are quoted by the manufacturer as being the same as those I sourced some years ago. Unfortunately they have changed the manufacturing method, and the current pins are slightly thicker, with much larger heads, and I believe, slightly softer. You will need to use a No 73 or 0.6mm drill to open out the holes.

The 0.55mm pins are in short supply, and so I have included some of these for the valve gear, otherwise use the slightly larger 0.6mm ones.

I continue to search world wide to find a source of pins as good as the original ones, that's' progress.

Assembly method.

You are urged to follow these instructions fairly carefully, in essence each of the sets of sub-assemblies are tested in the frames before main assembly. The order is not important, but it is essential they are all correct before the final 'one off' event.

You now need to build 5 main sub assemblies and take three assembly steps

1. Main frames.

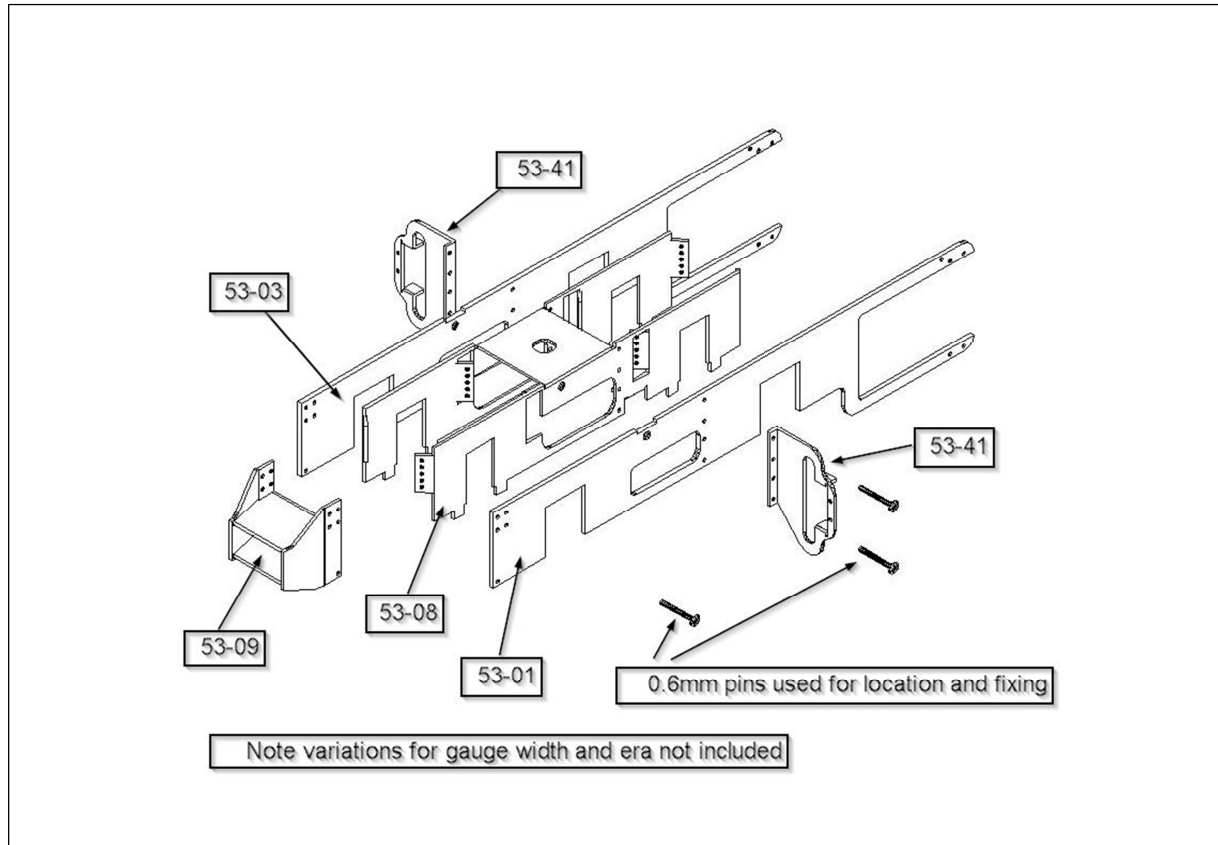

1. Use at least 3 pins to locate the inner and outer sides of the frames (1,2,3&4), Fig 1, and pin down to a piece of cork.
2. Use plenty of flux to help flood the area between the two pieces with solder, but avoid the pins !
3. Remove the pins one by one and clean up all the sides, edges and holes.



4. Locate the mid frame spacer (8),
5. bend the spring tabs out by 45 -60 degrees, **do not bend to a full 90 degrees**,
6. do not forget to bend out the two tabs for mounting the pickups.
7. Carefully fold each side to 90 degrees, and thread two pins through the motion bracket holes to locate,
8. hold with an engineers clamp or similar, Fig 3 & 4,

9. and solder in position on a flat surface (a small mirror or piece of float glass).

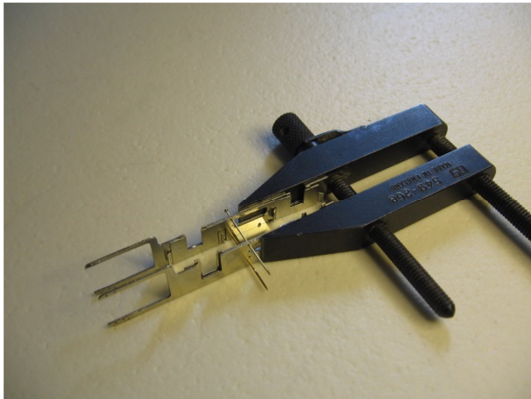

Fig. 3

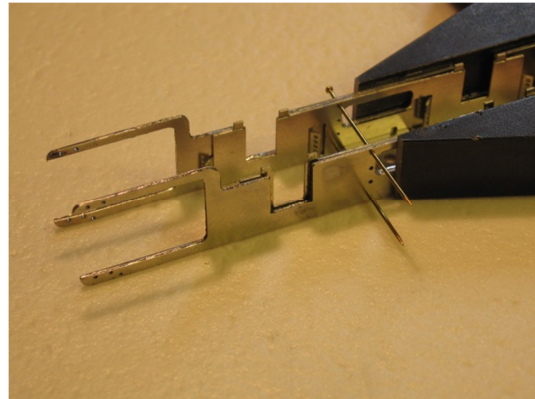

Fig. 4

10. Trial fit the bearings and ensure they move easily in the frames, and
11. add the 28swg Phosphor bronze wire springs,

Note: the packing list contains a very important instruction.

*Note the wire axlebox springs should now be made from 0.36mm piano wire,
not phosphor bronze wire.*

I add to that: **do not cut the piano wire** with flush cutters. Make sure you have cutter capable of cutting steel.

Fig 5 & 6. They usually fit in the middle holes, and turn over opposite ends to stop it spinning, ensuring it is free to move.

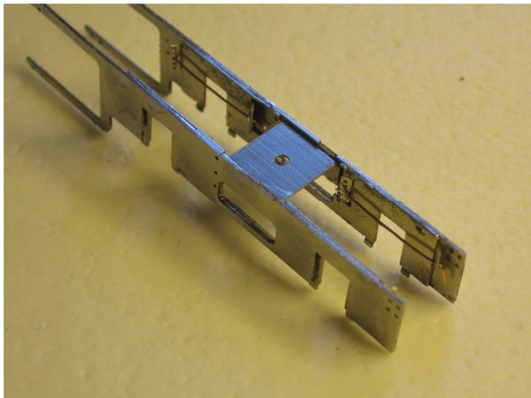

Fig. 5

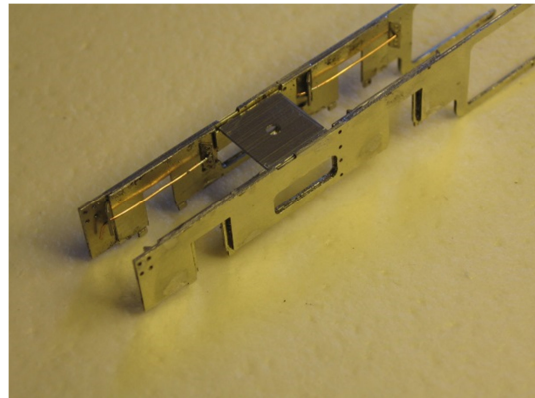

Fig. 6

12. Add the rear frame stretcher, (9 or 10), Fig 7-10.
13. There are **two options**, a plain end for pre 1946 versions, and a tapered end introduced later to allow the steam brake cylinder to be fitted.
14. Do not fit anything at the cylinder / bufferbeam end.

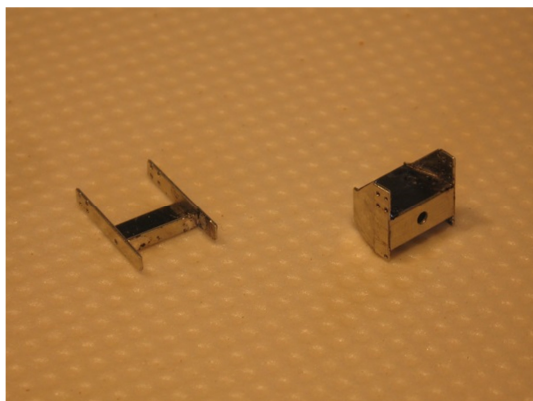

Fig. 7

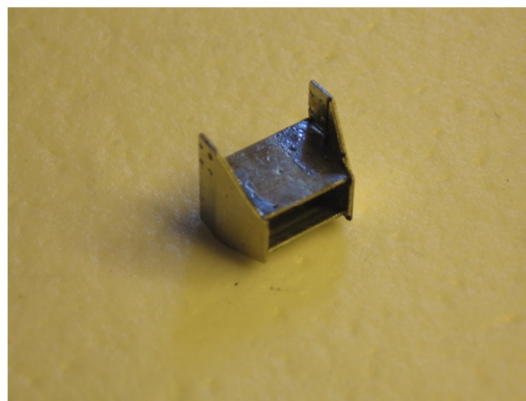

Fig. 8

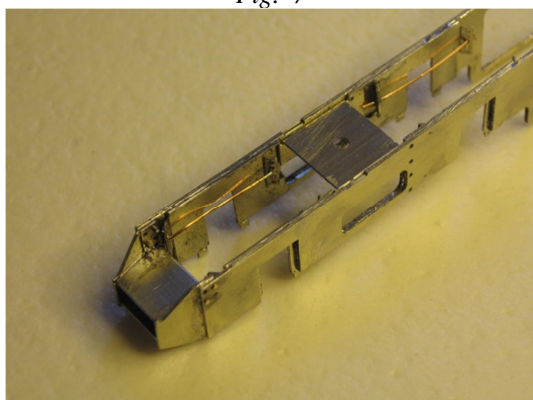

Fig. 9

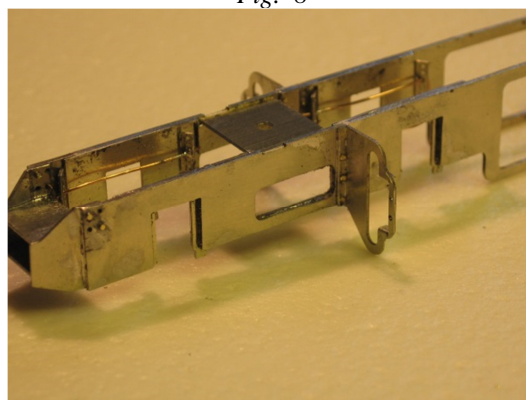

Fig. 10

15. If mechanical lubricators are to be fitted drill out the two half etch holes in the motion brackets **before** removing from the fret,
16. fold and strengthen the folds with a fillet of solder **before**
17. attaching to the main frame. Fig 11 & 12.
18. Remember the difference of wide (40) and narrow (41) options.

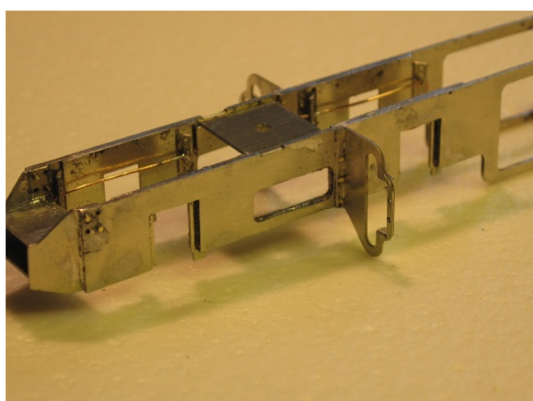

Fig. 11

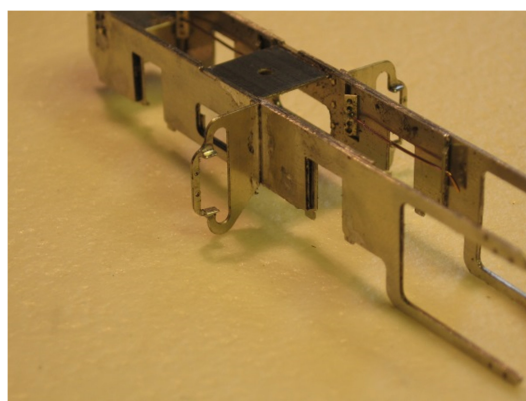
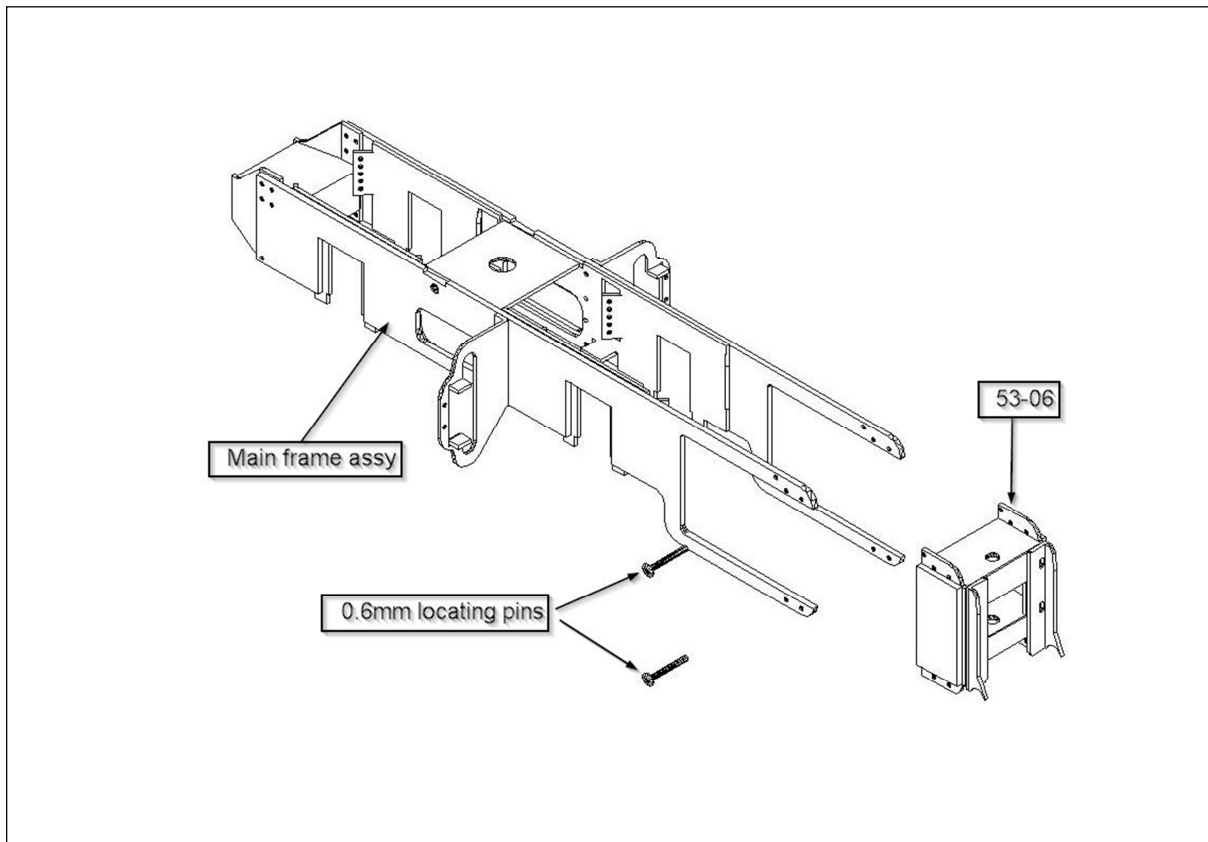

Fig. 12

2. Front buffer beam



19. Determine what sort of drain cock mechanism is needed on your particular bogie.
20. Drill out the 1mm hole before soldering the sides to the front if you need the mechanical linkage for cocks on The Earl or DLG (at the moment).
21. Take care when cutting out the fret to keep the side pieces together to aid folding and assembly.
22. **Remember the half etch lines are on the inside.** Fig 13 - 20.
23. The crash bar brackets are left to one side for later use.

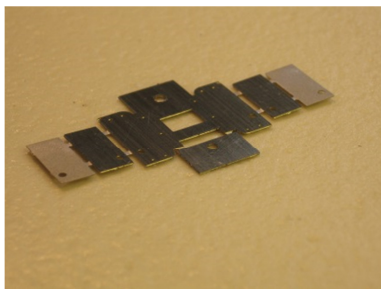

Fig. 13

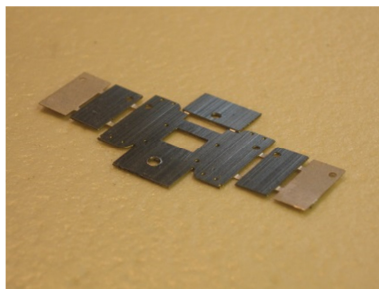

Fig. 14

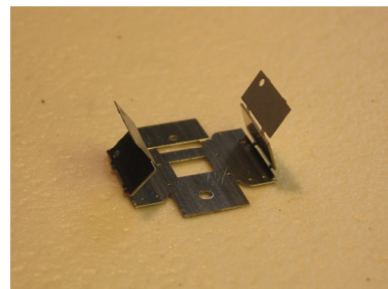

Fig. 15

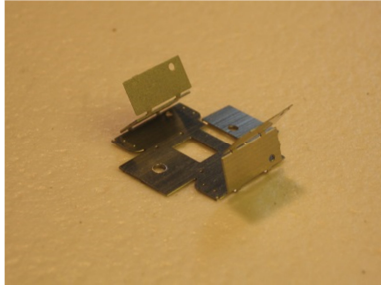

Fig. 16

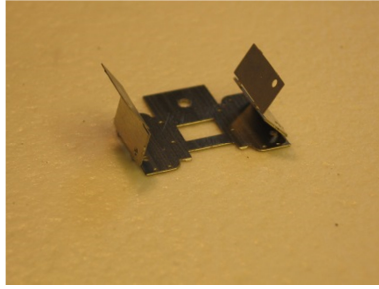

Fig. 17

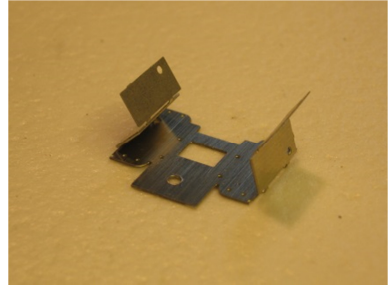

Fig. 18

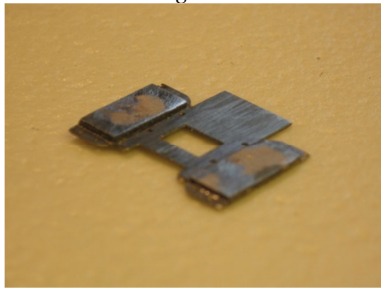

Fig. 19

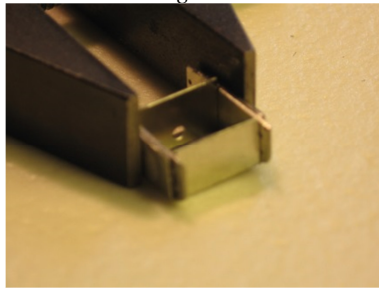

Fig. 20

24. There is a gap between the bufferbeam assembly and the cylinder block.
25. Once available, slide the cylinder block into the frames, and then
26. adjust the fit by filing the centre plate of the bufferbeam assembly to allow the pins to hold the assembly into the frames without straining things.

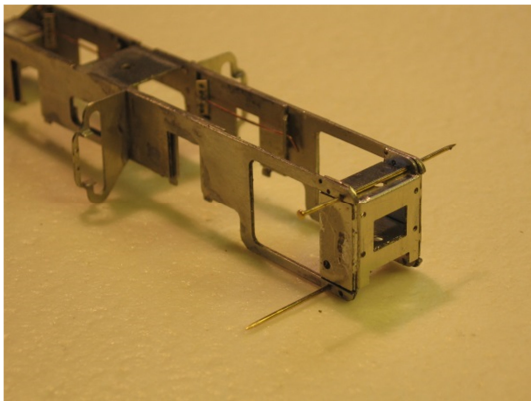

Fig. 21

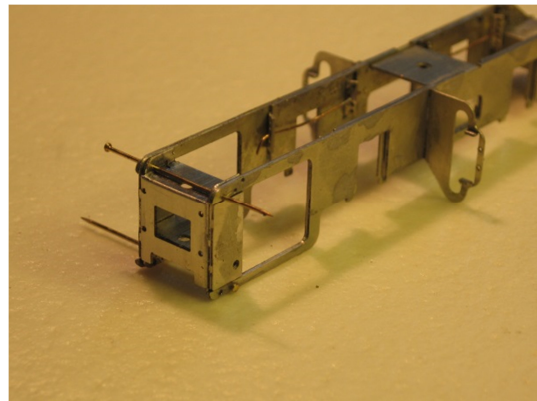
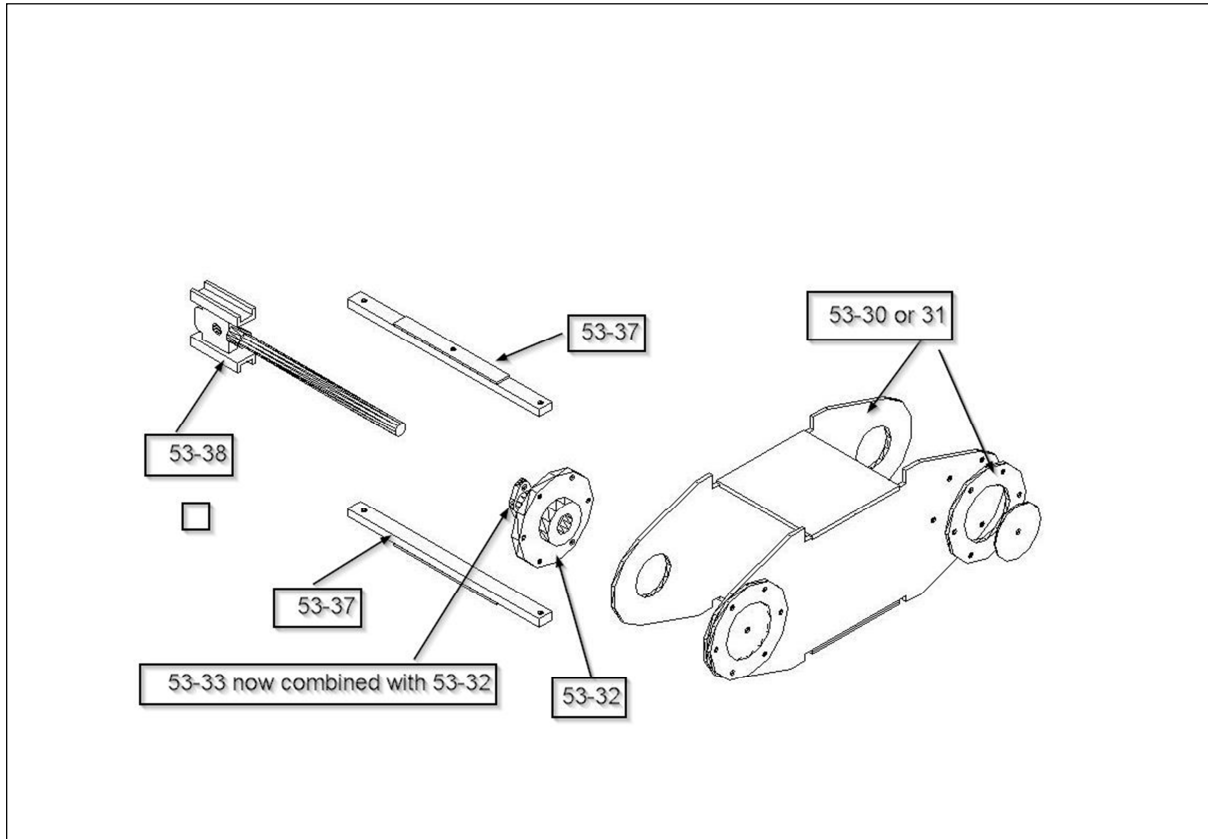

Fig. 22

27. There is a half etch guide line to show where a pre- 1946 bogie should be cut away.
28. Your particular type of coupler should be trail fitted at this stage.

3. Crosshead, cylinder end casting and connecting rods.



29. It is important that the crosshead runs without binding in the slidebars and cylinder end casting.
30. Run a 1.2mm drill through the piston rod gland (34),
31. Try not to touch the flats for the slide bars to sit on until both castings are attached to the cylinder block.
32. Solder the gland into the flange, with 0.55mm pins top and bottom. Solder paste is useful here.
33. Clean up the crosshead and piston rod(38), and
34. drill out the hole for the coupling rod fixing to 1.0 mm (14 B.A. clearance), and
35. cut the rod off to a length of 14mm beyond the crosshead.
36. File and polish the piston rod down to 1.2mm dia.
37. You can polish the piston rod by running a polishing mop along the rod.
38. **Do not put** the crosshead in the chuck using the piston rod in a 'Dremel' type mini drill. It runs too fast, and **will wreck the part**.
39. Make up a connecting rod (55).
40. The crosshead end is splayed out 4mm from the centre of the little end.
41. Solder the fork and then bend back both sides to parallel using some scrap to press 1mm together.
42. Countersink the rear half.
43. **It is important** to ensure the 14 B.A. Csk bolt is **not proud** of the width of the crosshead.
44. The clearance for the coupling rod is very tight on the prototype, and so the model is as well.
45. Countersink the rear of the crosshead a little as well, and ensure which side it fits.
46. Clean up the rest of the casting.
47. Remove the rod and bolt and set aside.
48. The slidebars are in pairs, divide one etch into two strips and one half etch on the top, and fold into one piece. Use a pin at each end whilst soldering together, but **only** the cylinder end is need to protrude through the bottom of the bar.

Cylinder block.

49. Two inner sections are on the fret, as noted above for wide (30) or narrow (31) centres.
50. I now found it better to add the cylinder end castings to the frame, the three bolts should be on the outside, visible in the distinctive gap that the casting is away from the cylinder itself.
51. Solder into position from the inside before adding the wrapper.
52. Check the casting is upright by inserting a pin into one of the slidebar fixing holes. If you forget to do this, it is possible to fix the castings afterwards, using a piece of scrap as a spacer, and solder to the frame on the inner side of the casting.



Fig. 30

53. Fold up, solder and then fit the outer wrapper (39), the two holes in the wrapper are for drain cocks, so go to the bottom of the assembly, the full thickness areas are the flats, and go on the inside of the piece.
54. Clean up, the wrapper is slightly oversize, and so
55. file the sides flush and the ends to the notch in the main body.
56. Check you can slide the block onto the frame front
57. Fold up and sweat together the slide bars, with a pin in each end.
58. At the end with the hole closest to the end leave 2mm of pin showing,
59. at the other end file down flush,
60. and file down to 1.2mm wide.
61. The half etch makes a hump on the bar on the side away from the flat running surface for the slidebar.
62. Tin the cylinder castings for the slide bars,
63. sweat the bars in position using the crosshead as a guide. Fig 31 - 34 **Fig 31-33 and 35**

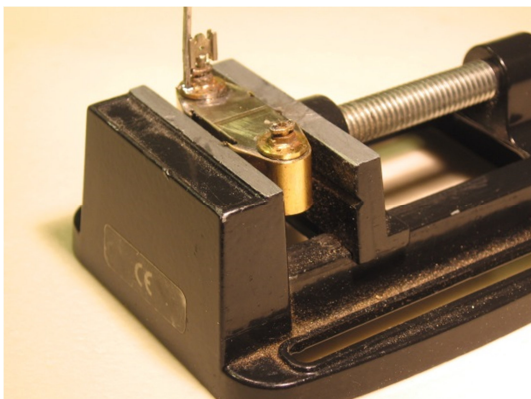

Fig. 31

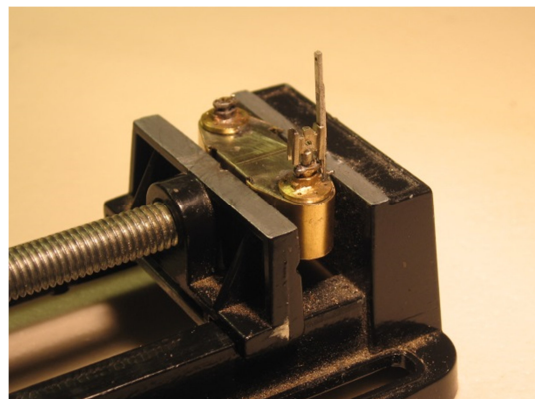

Fig. 32

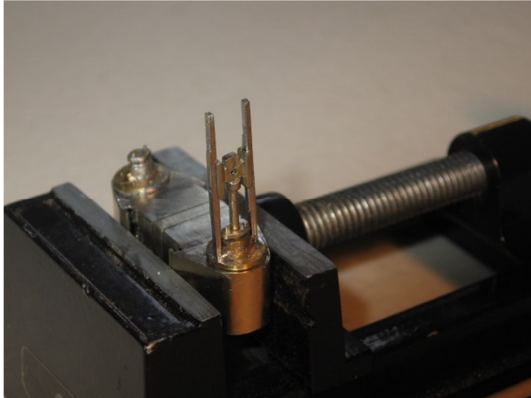

Fig. 33

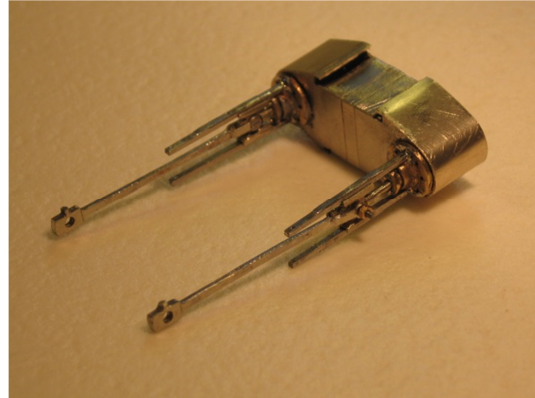

Fig. 35

64. Ensure the crosshead can run freely right up to the cylinder casting.
65. Add the front cylinder covers, using the full disk against the block, with the annular ring to the outside, ensure the pins do not protrude through the casting too far and interfere with the piston rod. Fig 35 & 7. [Fig. 36-37](#)
66. The rectangular cylinder flange (32) is fitted across the middle of the front of the casting,
67. the half-moon shapes are fitted to the frames during final assembly.

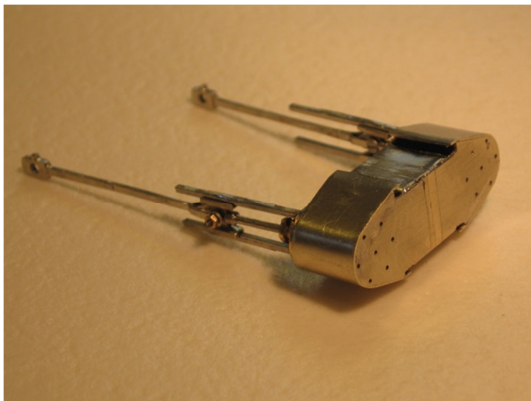

Fig. 36

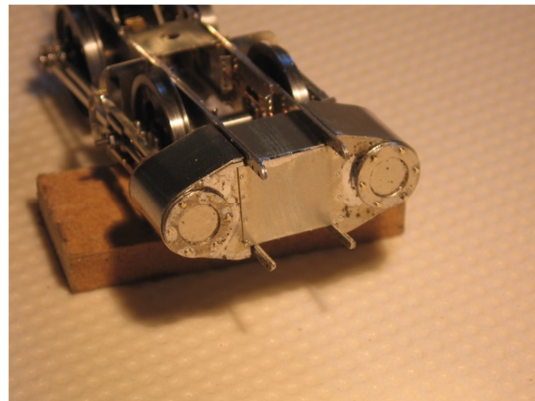
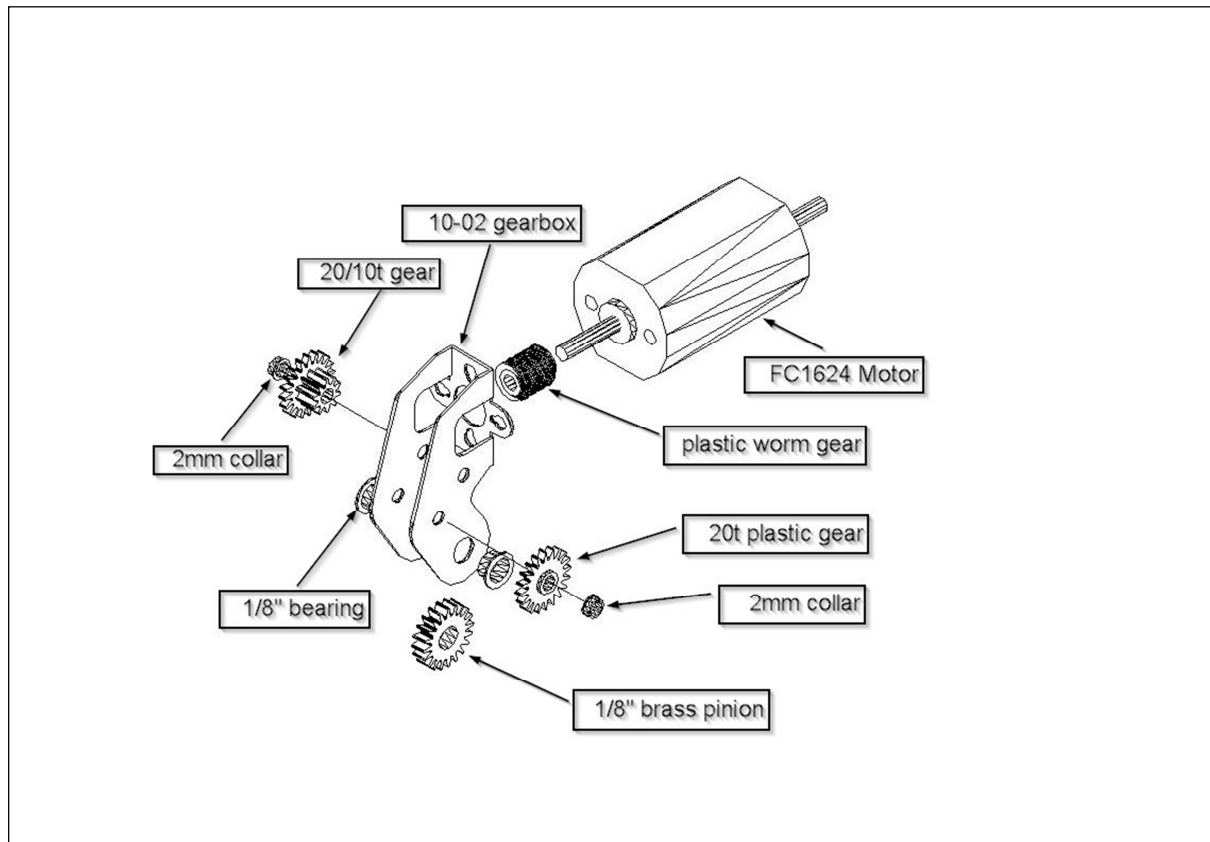

Fig. 37

68. Refit the connecting rod and check they fit in the frames.
69. Check the front buffer beam fits as well.
70. If tight, file down the coupling mounting plate in the front buffer assembly.
71. Keep the assembly together for final assembly.

4. Motor & Gearbox.



72. The fret contains a gearbox that can be used with either 16.5 or 14mm gauge.
73. To get a gearbox thin enough the assembly is slightly 'one sided', ie the final drive pinion is not central on the drive axle, but the combined assembly of three washers and the pinion is.
74. Fold up the gearbox fret and
75. run a bead of solder on the inside to strengthen (on this type of box I often use an offcut of the fret and make a strengthener to fit over the box to keep the sides the correct distance apart).
76. The main axle bearings are located with the flange on the outside,
77. again solder in place and then
78. check a plain axle is free running in the bearings.
79. You may need to ream or file out the motor bearing hole if necessary.
80. The flat can motor is mounted with the flats top and bottom.
81. The rear shaft **can** be cut with a thin grinding disc as close as possible to the rear bearing,
82. **or left longer** and a flywheel fitted.
83. Check the fit of the bearings and idler shafts,
84. ream the gearbox sides as necessary.
85. These shafts must be filed close to the gearbox side, and protrude no more than 1/2mm each side to allow for fitting between tight frame sides. Fig 38.
86. Remove the motor for fitting later.

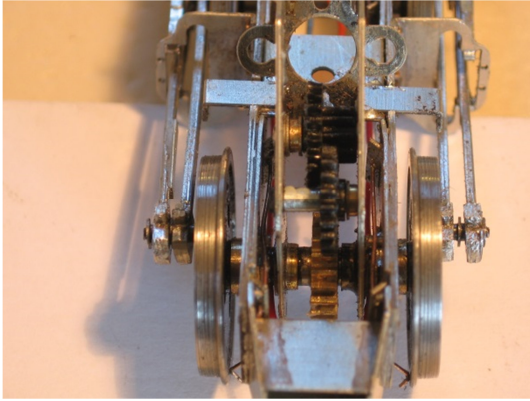
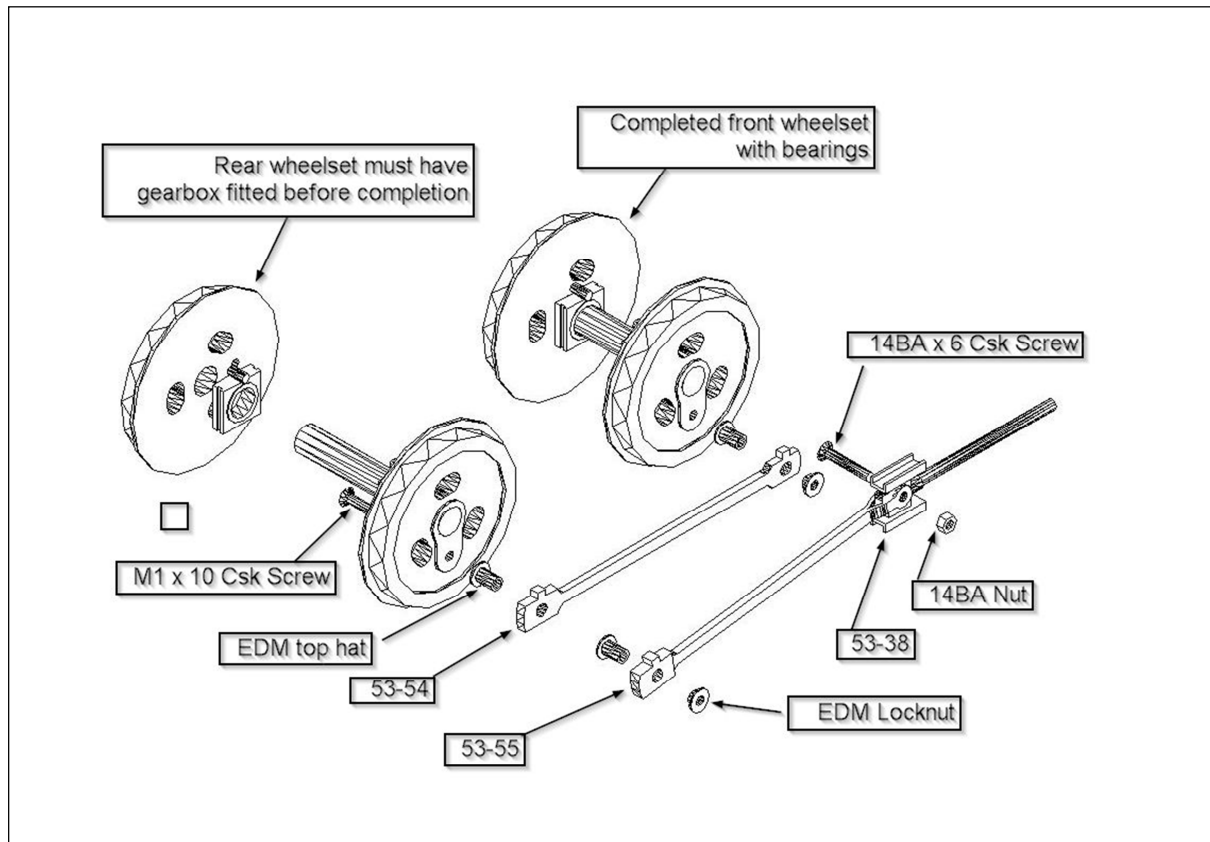

Fig. 38

87. Ensure you assemble the drive train correctly.
88. The double gear is driven by the worm, the single gear is the idler between the double gear and the axle pinion.
89. The 2mm diameter sleeves are used to space the gears on the shafts.
90. As this is a slim gearbox there is no need to glue the spacers onto the shafts.
91. A little solder can be used to hold the axle bearings in place,
92. I also hold the cross shafts in place with a little solder on the side away furthest from gears **or use** a small amount of Loctite 601.
93. Ensure all runs freely, and that you can slide the pinion along the axle.
94. **Do not fix** the pinion on the axle at this stage.

5. Wheel sets and coupling rods.



95. The wheels need preparing with a countersink for the M1 crankpin bolts.
96. The cylinder end axle needs spacer washers and bearings threaded onto the axle.
97. Note the bearings are asymmetric, ensure the wider side to the outside.
98. For 16.5mm gauge, 14.5mm back to back, you should need three full and one half washer each side of the front wheel set.
99. The rear set can have a little play and so use only three washers per side. There are extra 1/8" washers attached to the gearbox fret.
100. For 14mm, 12.5mm back to back, you should need 1/2 washer each side, and of course the axles need shortening.
101. Quartering can be done by eye, but needs great care, or use a quartering jig.
102. Align each axle, attach the coupling rods and check for any binding.
103. When the chassis is viewed from above, the crankpin of the right hand wheel is in the fully forward position and the left hand crankpin is at the top. This means that the right hand wheels are leading the left hand wheels by 90 degrees and is the norm for most British locomotives.
104. Build up the front wheel set, wheel, washers, bearing one side, bearing other side, washers,
105. finally the other wheel.
106. Ensure the wheelset fits in the frame with the cylinder block and bufferbeam in place, and that it runs freely with minimal play side to side.
107. Form the coupling rods.
108. The **rods are handed** on the fret,
109. **ensure** you fold them all the same way to end up with an opposite pair.
110. Due to the tight clearance by the crosshead there is only one 1/2 etch on the crosshead end of the coupling rods, this 1/2 etch goes inboard to each wheel.
111. Attach the coupling rods with the 1mm short top hat, reduced in length if possible, and a 1mm tapped outer.
112. Check the clearances and ensure free running in the frame.

113. Set aside. Fig 39 & 40.

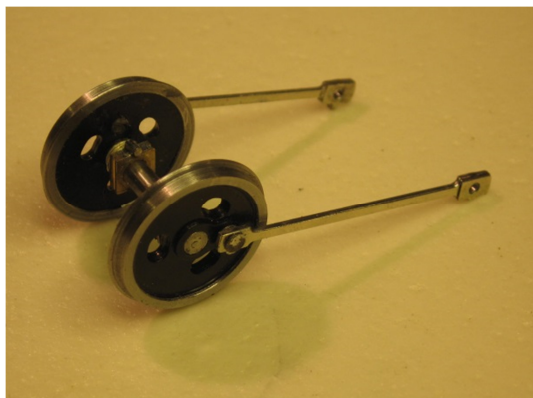

Fig. 39

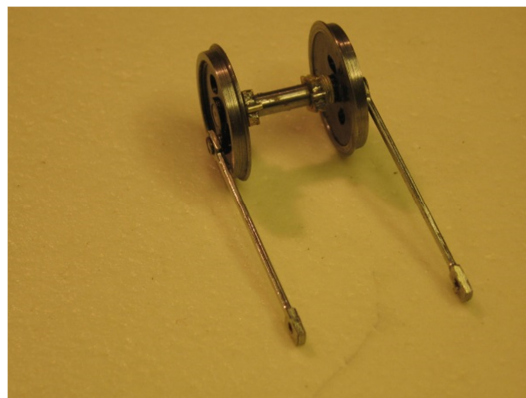
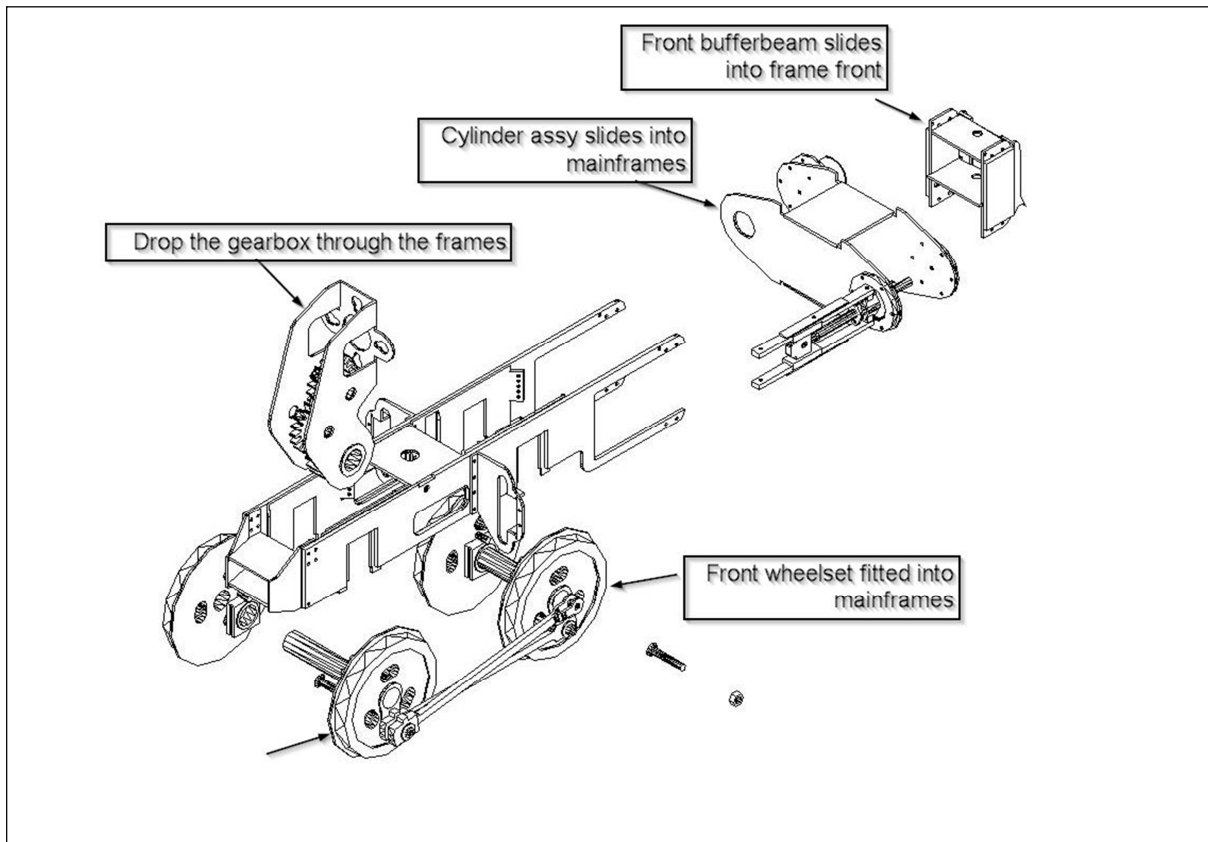

Fig. 40

114. The rear wheel set must be assembled in the frames, but
115. **ensure** the pinion is reamed out 1/8" to enable it to slide on the axle.
116. One wheel can be pressed partly on, the rest **has to wait** for final assembly.
117. The long top hat can be filled down to fit through the connecting rods with a little play.

6. Main Assembly



118. You should now have a main frame, cylinder block/slidebar assy, front bufferbeam, front wheelset, rods, and gearbox, Fig 50 & 51.

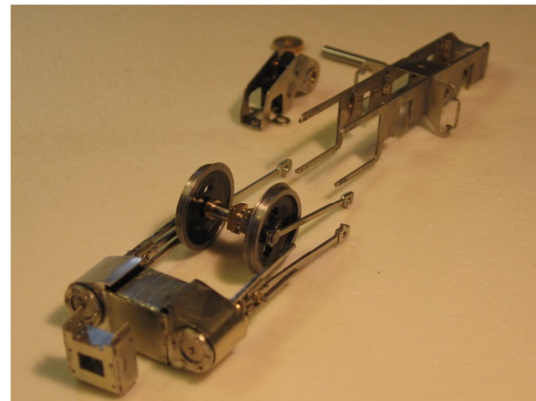
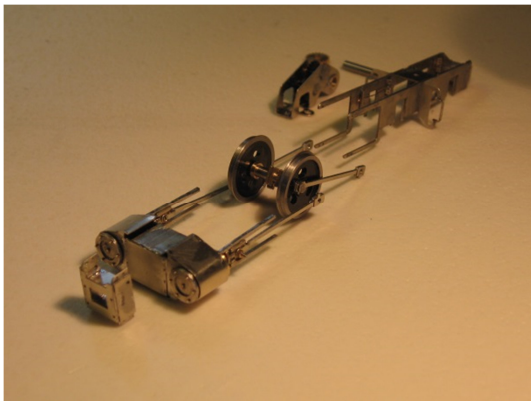

119. Check the front wheelset still fits and runs true, remove. Fig 52.
120. It is worth chamfering the ends of the slidebars by about 2mm to ensure the connecting rod does not foul the ends.

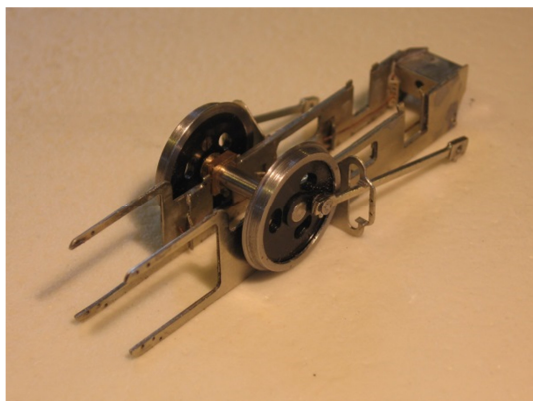

Fig. 52

121. Fit the cylinder block with crosshead and rods, and
122. locate by adding the front buffer beam, and
123. secure with a couple of pins. Fig 53 & 54.

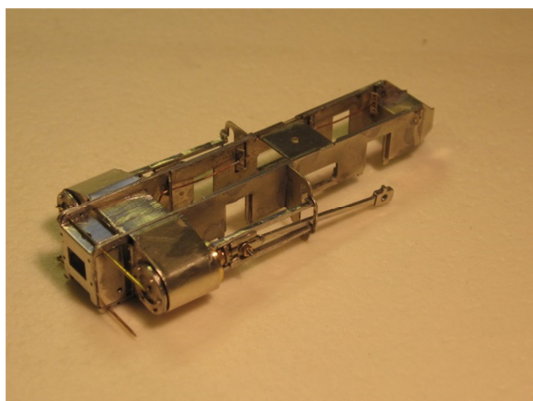

Fig. 53

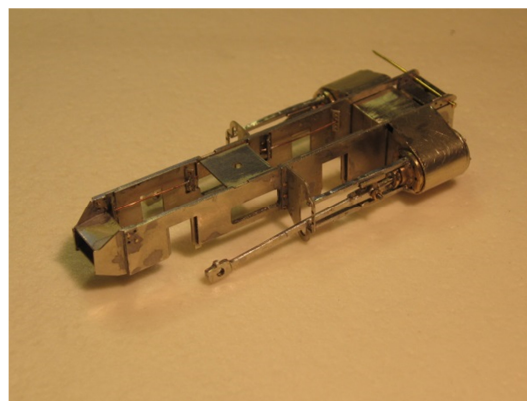

Fig. 54

124. Return to the front wheelset,
125. check the clearance between the rear of the crosshead and the crankpin ends. Fig 55.

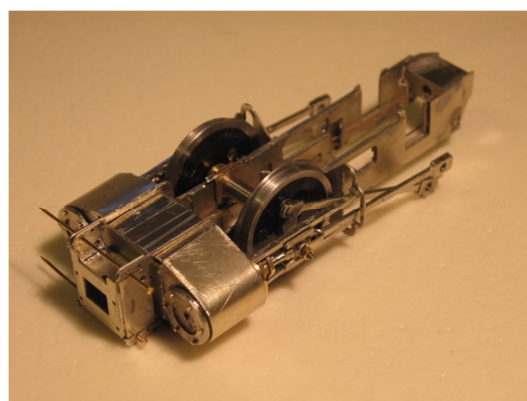

Fig. 55

126. When all is well remove the front wheelset, cylinder block and bufferbeam.
127. Now is point of no return, or at least a difficult disassemble....
128. Thread the gearbox from the top into the frames. Fig 56.

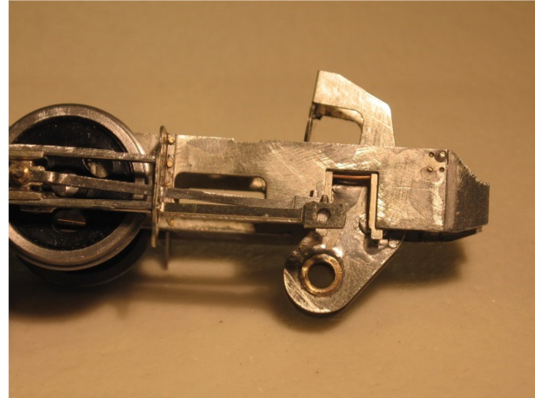

Fig. 56

129. Feed the axle with one wheel,
130. add washers, and one bearing.
131. Feed the rear axle to the gearbox, and through the pinion.
132. **Do not glue** the pinion at this stage.
133. Complete the axle,
134. press on the other wheel (you can fiddle it all in a small vice, whilst the rest of the chassis gets in the way), Fig 57, at the same time trying to judge the quartering.

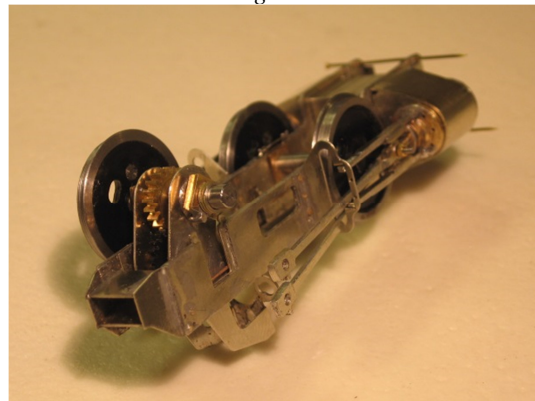

Fig. 57

135. Drop the bearings into the frame, and
136. secure with keeper wires.
137. Add the crankpin top hats, and
138. carefully feed on the connecting rods.
139. Assess by eye how good your quartering is.
140. If rods are binding adjust the wheel set that appears to be out of quarter by holding the opposite wheel and moving the other wheel a small amount each time, then check for binding.
- 141. Only move one wheel.**
142. Using the quartering tool is still a fiddle, but worth the expense to get it right.

143. Replace the front wheelset, feed the coupling rods through the motion brackets, ensuring the rods are the correct way up.
144. You can now check for correct quartering and free running of the wheelsets.
145. It is essential that all the keeper plates are fitted to the lugs on the frames at bottom of each axlebox.
146. You can use a piece of scrap fret of wire about 0.8mm wide. If this is not done the axles can drop and cause binding of the coupling rods.
147. Fit the free ends into top hats on the crankpin screws on the rear wheels.
148. The long top hats can be shortened by careful filing, but the sleeve must be longer than the width of the coupling rods.
149. You need to achieve a free running chassis at this stage, with no binding. Fig 58.

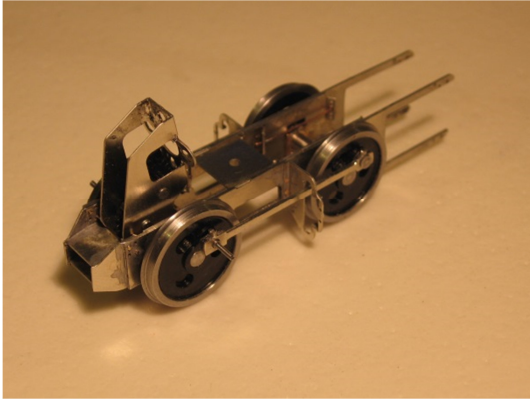

Fig. 58

150. When tightening the M1.0 tapped top hats only use smooth faced pliers, serated ones will dig into the thin material and wreck them.
151. When happy, add the cylinder block back again, and attach the connecting rods.
152. Again ensure there is no binding.
153. The free ends of the slide bars can be soldered to the motion brackets, and the pins soldered in place to hold the bufferbeam in place.
154. There is **no need** to solder the cylinder block itself into position.
155. Next, the pinion is glued to the rear axle using Loctite 601 or similar.
156. It is important to keep the axle and its bearings away from the loctite. I try to bond things in the morning and check every 15 minutes, then each hour for a least 6 hours to ensure the axle keeps running freely.
157. Keep checking everything runs free and is not glued up, even up to 24hrs later.
158. Lubricate the gear set with Ceramic Grease (Tamiya make some for slot racing cars).

7. Pick ups.

In an ideal world pick ups would be attached on top of the frames to rub on the top of the wheel treads. However, a Fairlie bogie is rather busy on the top, with rubbing plate, bearing, and the top of the cylinder end wheel being visible. I have decided to fit thin wire pickups to the back of the wheels, on the bottom of the frame to keep them out of view.

159. Fit two pieces of PCB to the frames,
160. cut two centre lines through the copper using a thin razor saw.
161. Fold up two pickup out of 31 swg phosphor bronze wires.
162. The trick is to fold up both pickups for one wheel set at the same time, bend to shape, hold them in place whilst soldering to each side of the PCB.
163. You can adjust one side at a time without fear of the springing into the distance if you fix both sides. Fig 59 - 61.

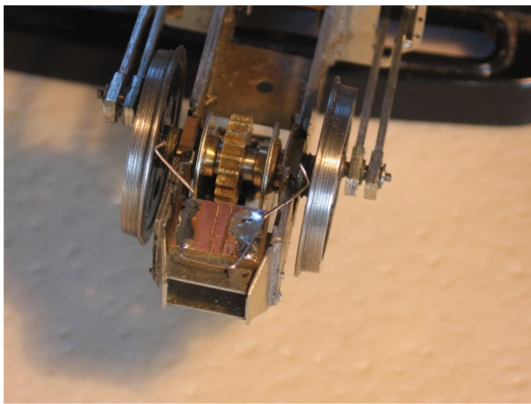

Fig. 59

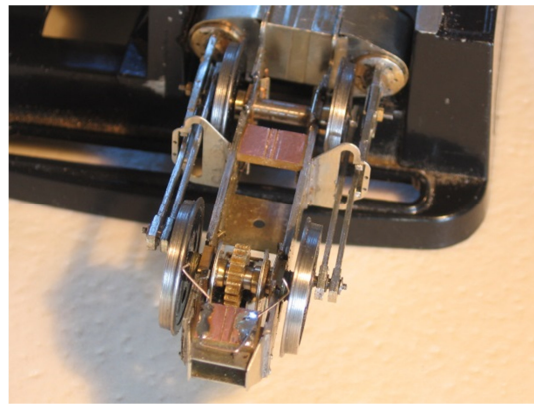

Fig. 60

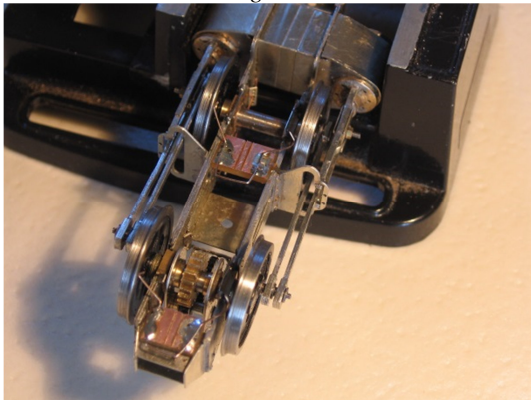

Fig. 61

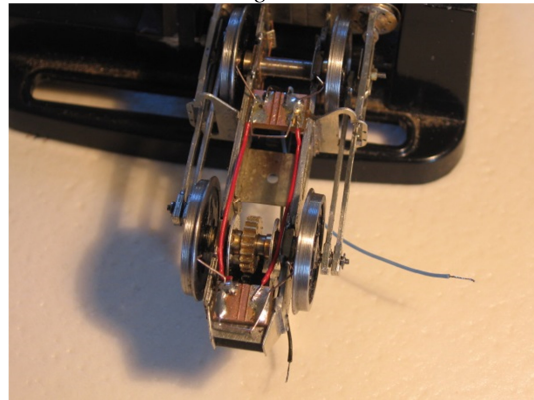

Fig. 62

164. I would also fit the interconnection PVC coated wires as well. Fig 62.
165. When both sides are in contact with the wheels cut the centre section of the wire out.
166. Refit the motor, and check for free running.
167. You will need to remove the motor to fit the cross stretcher later.

Running Checks

168. I always run my chassis as soon as I can to see if there any tight spots, and then
169. run them round my test circuit for a couple of hours to run in.
170. Once everything settles in the finishing can begin.
171. Do not forget to lock the crosshead bolts with a tiny amount of threadlock,
172. and shorten them.

8. Detailing

There are four areas to complete, front crash bar, brake assembly, drain cocks and lubricators. I suggest a careful look at the prototype images to ensure your model is as accurate as possible.

7.1 Crash bar

173. **Depending upon the version** being built the front crash bar can be added.
174. The brackets should have been kept to one side from the front buffer beam etc. The bar is 2mm dia and 22mm long.
175. Fit using pins and level the bar before final soldering. Fig 70.

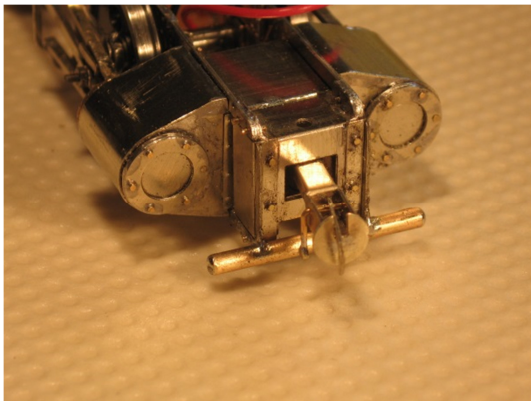

Fig. 70

7.2 Brake assembly

176. The brake hanger brackets are set out to let the brake blocks align with the treads of the wheels.
177. Align by using a piece of 1mm bar threaded through both sides of the frames and the bracket being fitted.
178. Ensure the brackets are flush with the top of the frames, otherwise the rubbing plate or bearing bar will not swivel. Fig 72.
179. The hangars, brake blocks and cross shaft can be fitted.
180. There are alternative types of brake blocks that were fitted at various times. Fig 71.



Fig. 71

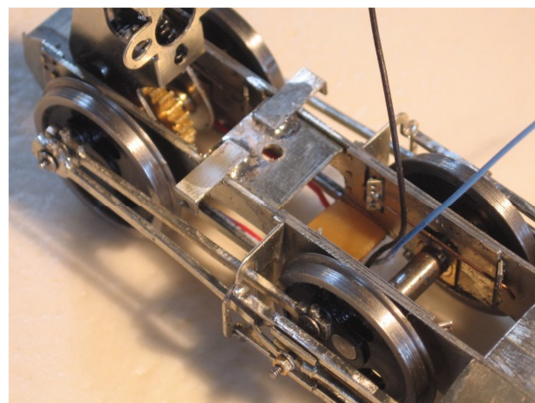

Fig. 72

181. Tips : To fold the brake hangars put one side in the vice, and fold to 45 degrees.
182. Turn over and fold the other side to 45 degrees (use a square drift to push over).
183. Fold up a piece of scrap fret twice, to make a piece of three thicknesses.
184. Place the hangar on the bench, hold down in the centre with the 3-thickness piece, and
185. fold the two sides to vertical with a pair of smooth end pliers.
186. Finally, squeeze up in the vice and then remove the 3-thickness piece.

187. Note the brake hanger end is bent 'backwards' for the cross shaft to fit.
188. The end of the hanger is bent around a 0.6mm pin.
189. The two sides of the cross shaft are soldered together, and then
190. a 0.6mm drill run down the half etch in the ends to make **two** holes to insert pins.
191. If you are fitting a rubbing plate I advise opening out the centre hole in the frame inner to enable a 10B.A. cheese head to pass right through the frame inner, **do this before fitting** the brake cross shaft.
192. Make up the assembly, and
193. solder in position
194. ensuring the blocks do not touch the treads, and the brake gear does not bind on the coupling rods.
195. Fig 73 – Fig 77

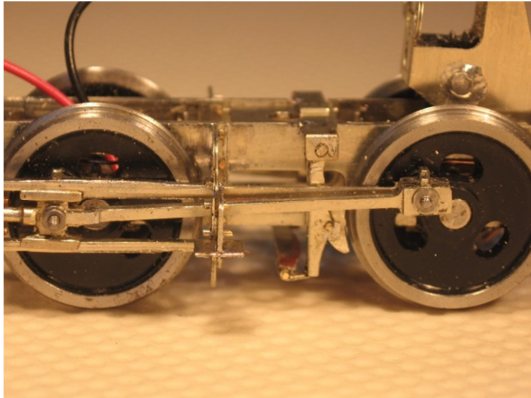

Fig. 73

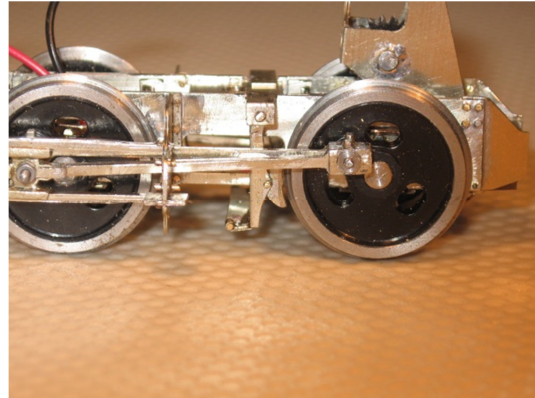

Fig. 74

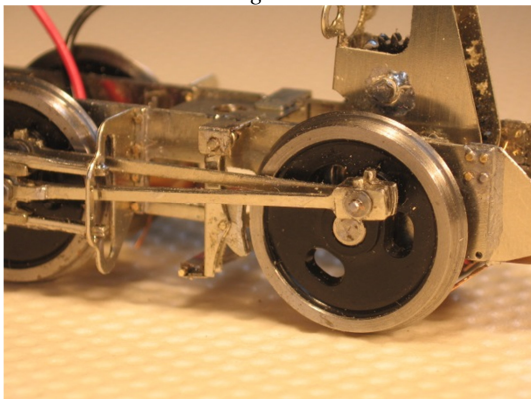

Fig. 75

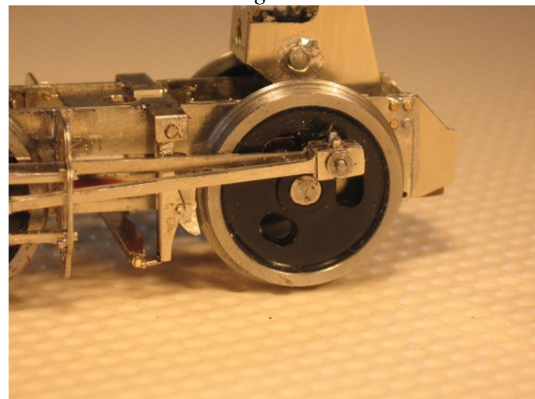

Fig. 76

7.3 Drain cocks

196. The drain cocks may be the mechanically operated type, in which case the shaft, lever and operating bar need to be fitted to the castings.
197. The steam operated types (for Merddin) need to be fitted carefully to ensure they are not lower than the wheel treads, otherwise they will foul pointwork.
198. The steam operating pipe to be fitted out of .035mm copper wire.
199. Fig. 80-81

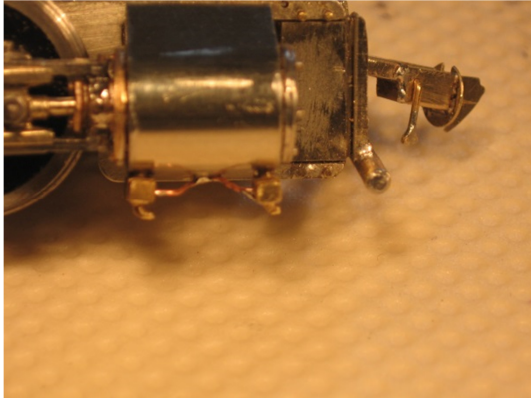

Fig. 80

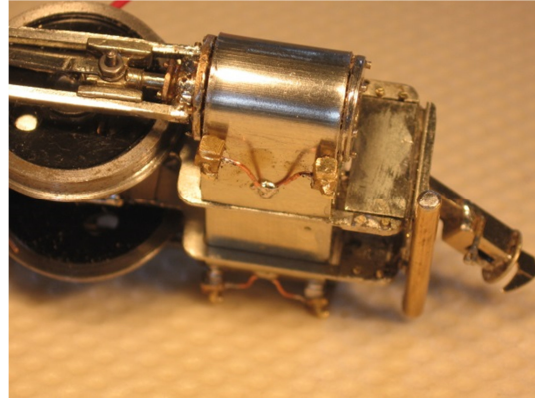

Fig. 81

7.4 Lubricator

The preservation era bogies started to have mechanical lubricators fitted. The standard now is to fit two four way lubricators per bogie, on the drivers side. Only one lubricator per bogie was fitted initially on Taliesin and Merddin.

200. Fit the bracket carefully to the motion bracket, it is delicate, and then
201. solder on the lubricator castings.
202. The pipes are 0.35mm again, and bent towards the centre fixing bracket, and then another 90 degree turn towards the main frame.
203. I solder them to the main frame and clip off any excess.
204. Ensure the pipes are below the top of the rubbing plate, and do not foul the fixing screws.
205. Tip : To aid assembly bend the copper wire in a U shape and solder both ends into the lubricator before cutting and separating the 'pipes'. Fig 83.

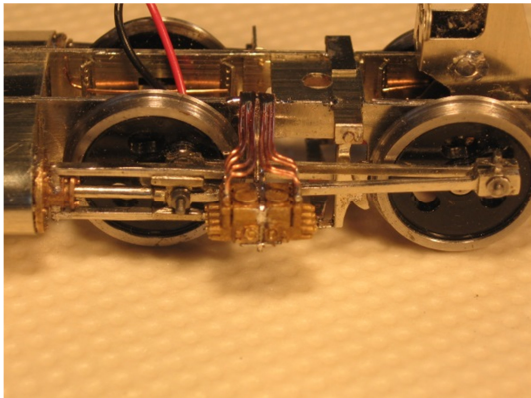

Fig. 83

206. Centre bearing and rubbing plate. The combination of rubbing plate and cross bar depends upon the model being built. Generally the rubbing plate is soldered to the top of the chassis.
207. Ensure the centre holes line up.
208. The lower hole in the cross member should be opened out longitudinally to allow the bearing to swivel in line with the frames.
209. A scale size rubbing plate is included on the etch. If there is excessive 'wobble' it may be worth trying the larger plate made from scrap material, I have used plates up to 25mm wide x 10mm long.
210. To centre the plate fit a 10B.A. nut and bolt through the hole before locating into the bogie. Fig 82.

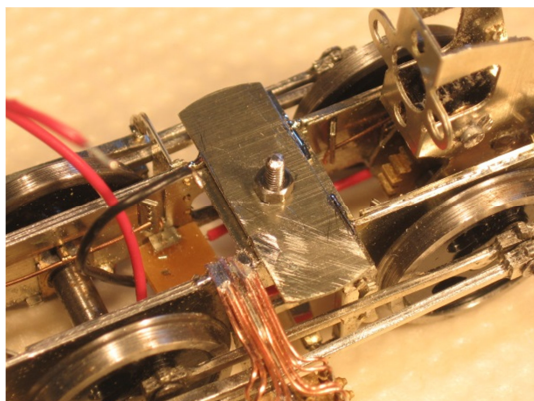

Fig. 84

211. Cut down the 10 B.A. screws to be about 5mm long,
212. ensure the centre screw does not lift the motor up excessively.

Wiring and DCC options.

If the pick ups are correctly adjusted I have found I can get reliable running from pickups on two axles. However, on double engines there is a benefit to joining the pickups from both bogies together. I drill holes through the rear of the bogie, and joining these with a two pole connector to allow easier disassembly.

For double engines I recommend fitting a decoder to each power bogie, and take power from the 'bus' linking the two bogies.